

URW-295

(2.9t x 1.4m)

The UNIC 295 is **Europe's most widely used mini crawler crane**. It is narrow enough to allow access through a standard doorframe, but has almost 3 tonnes of lifting power. It leads the way technically with an array of safety features including a computer-controlled, intelligent voice warning system.



Crane Specifications

Crane capacity	capacity:	2.9t x 1.4m
Max working radius	max:	8.41m
Max lifting height	approx:	8.8m
Rope length	max:	11.7m (4 fall), 23.4m (2 fall), 46.8m (1 fall)
Dimensions	folded:	2690mm (2905mm diesel & electrical dual) (l) x 600mm (w) x 1380mm (h)
Weight	unladen:	1850kg (1950kg with electric option, 1920kg with diesel option, 2090kg with diesel and electric dual option)
Point loadings	Due to the many variables involved, point loadings are only available on request	
Hook speed	approx:	10m/min (with 4 layers and 4 falls)
Telescopic system	boom length:	2.53 - 8.65m
	telescoping speed:	6.12m/20 seconds
	boom type:	5 section hydraulically telescoping boom, hexagonal box construction
Derricking angle/speed	approx:	0 - 78°/11 seconds
Slewing angle/speed	approx:	360° (continuous) 1.5min ⁻¹ (rpm)
Traction system	drive:	hydrostatic, step-less forward and reverse
	travel speed:	0 - 2.3km/h
	gradability:	20°
	track ground length:	1050mm
	track ground pressure:	48kPa (0.49kg/cm ²)
	track width:	180mm
Engine	manufacturer:	Mitsubishi (Kubota diesel)
	fuel:	petrol (LPG dual, electric dual and diesel options)
	maximum output:	9.6kW (13PS) / 2500min ⁻¹ (rpm)
	starting method:	electric and recoil start as standard
	tank capacity:	6 litres
Electric motor	power:	3.7kW
	voltage:	400v AC 50/60Hz
Standard equipment	computer controlled moment limiter (safe load indicator), computer controlled intelligent voice warning system, overload warning lamps, radio remote control, intelligent throttle activation	
Optional equipment	2 fall hook block, 1 fall hook block, LPG dual power, mains electric dual power (400v), diesel engine, low marking tracks, slew limitation	

- Capacity 2.9t x 1.4m
- Total width 0.6m
- Max working radius 8.41m
- Max boom length 8.65m
- Petrol powered, optional LPG dual, electric dual and diesel
- Zero length increase with electric option (except diesel)
- Operator control of outrigger extension
- Radio remote control as standard
- Working area limitation
- Slew limitation (optional)
- Intelligent throttle activation for economy and ecology

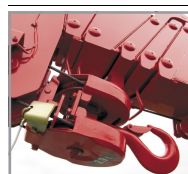
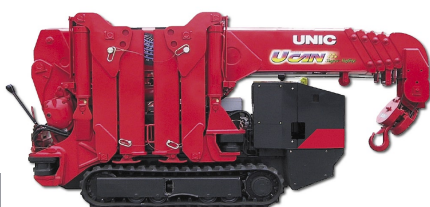

Automatic hook stow



Anti two-block system



Full safe load indicator



Overload warning lamps + auto stop + alarm

Rated Loads

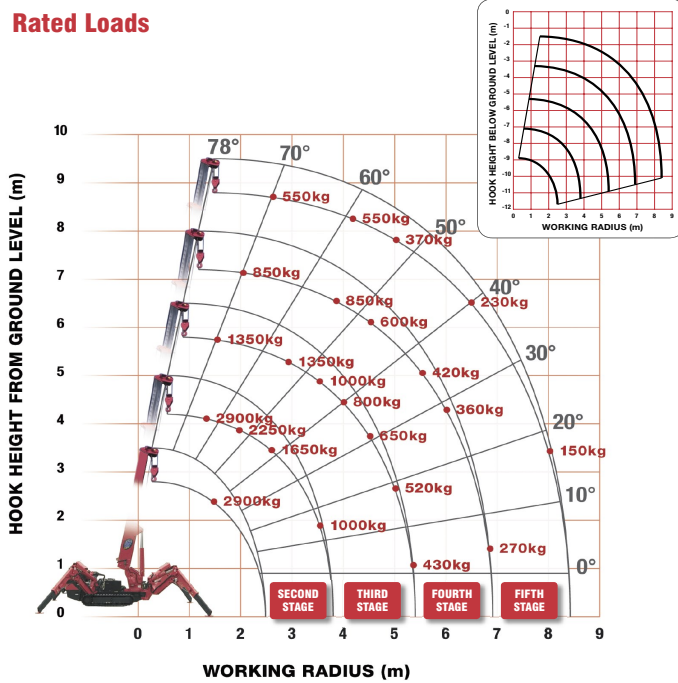

Outrigger Positions

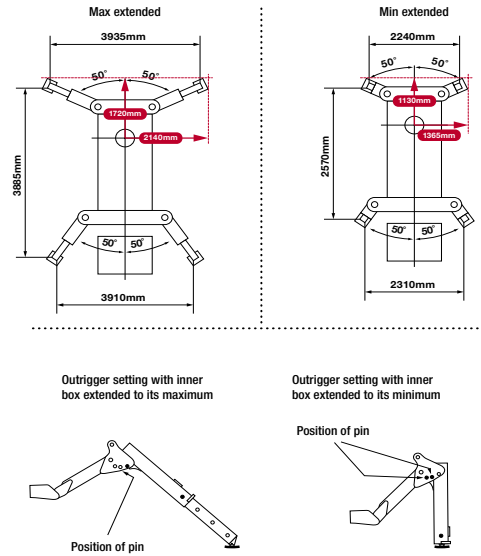

SECOND STAGE

SECOND STAGE EXTENDED 2.53 - 4.075M BOOM LENGTH

Working radius	m	up to 1.0	1.4	1.5	1.8	2.0	2.5	3.0	3.5	3.835
Outrigger Max-extended	kg	2,900	2,900	2,650	2,250	2,050	1,650	1,300	1,000	900
Outrigger Min-extended	kg	2,000	2,000	2,000	1,450	1,100	650	490	350	250

THIRD STAGE

THIRD STAGE EXTENDED 4.075 - 5.61M BOOM LENGTH

Working radius	m	up to 2.2	2.5	2.9	3.0	3.5	4.0	4.5	5.0	5.37
Outrigger Max-extended	kg	1,350	1,350	1,350	1,250	1,000	800	650	520	430
Outrigger Min-extended	kg	800	650	530	500	380	280	220	160	120

FOURTH STAGE

FOURTH STAGE EXTENDED 5.61 - 7.13M BOOM LENGTH

Working radius	m	up to 3.3	3.8	4.0	4.5	5.0	5.5	6.0	6.5	6.89
Outrigger Max-extended	kg	850	850	750	600	500	420	360	320	270
Outrigger Min-extended	kg	420	340	300	250	190	140	100	80	60

FIFTH STAGE

FIFTH STAGE EXTENDED 7.13 - 8.65M BOOM LENGTH

Working radius	m	up to 3.8	4.1	4.5	5.0	5.5	6.0	6.5	7.0	8.0	8.41
Outrigger Max-extended	kg	550	550	450	370	310	270	230	200	150	130
Outrigger Min-extended	kg	350	290	250	200	160	130	100	70	40	30

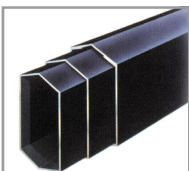

Hexagonal boom minimises sway

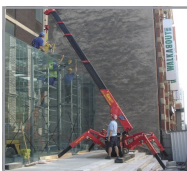

Level operation on uneven sites



Optional mains power

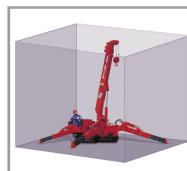

Working area limitation



Low marking tracks